

cob 1x6w gu10

ficha técnica

datasheet

ref. 5550486

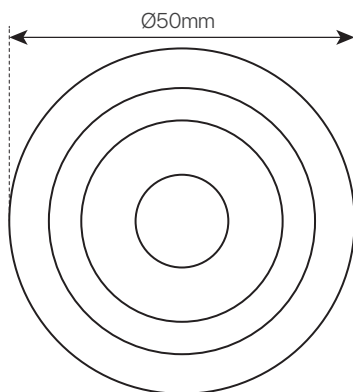
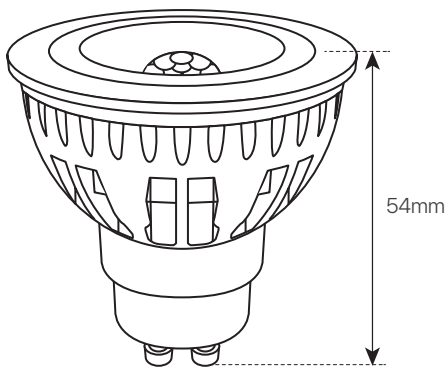

Nombre / Name	COB 1x6W GU10 DIMMABLE
Referencia / Reference	5550486
Materiales / Materials	Aluminio + PC / Aluminum + PC
Difusor / Diffuser	PC
Potencia / Power	1x6W
Temperatura de color / Color temperature	4200K
Flujo luminoso / Luminous flux	450lm
Dimable / Dimmable	Si / Yes
Ángulo de apertura / Beam angle	38°
Ángulo de inclinación / Inclination angle	-
IP	IP20
IK	-
F.P. / P.F.	-
UGR	-
IRC	-
Chip	EPISTAR COB
Driver	i-TEC series
Vida media (duración) / Average life	+20.000 h
Clase energética / Energy class	A+
Aislamiento eléctrico / Electrical isolation	-
Colores / Colors	Aluminio / Aluminum
Medida exterior / Product size	Ø50mm x 54mm
Protección contra Sobretensiones / surge protection	-
Tª (ambiente/trabajo) / Tª (environment/work)	-25°C ~ 40°C
Input	AC 100 ~ 265V
Output	-
Frecuencia / Frequency	50 / 60Hz
Peso / Weight	58g
Certificados / Certificates	CE RoHS
Garantía / Warranty	2 años